



Typical Applications

The HMC-C059 Wideband LNA is ideal for:

- Telecom Infrastructure
- Microwave Radio & VSAT
- Military & Space
- Test Instrumentation
- Industrial Sensors

Functional Diagram

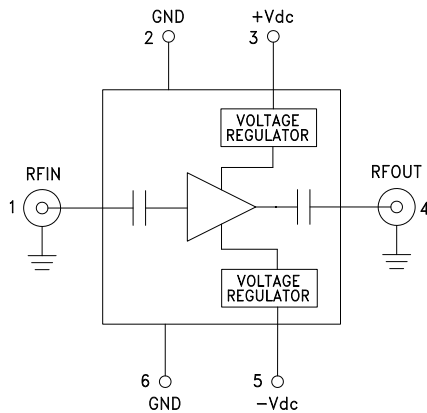

Features

- Noise Figure: 1.8 dB @ 8 GHz
- High Gain: 16 dB @ 8 GHz
- P1dB Output Power: +16 dBm @ 8 GHz
- Spurious-Free Operation
- Regulated Supply and Bias Sequencing
- Hermetically Sealed Module
- Field Replaceable SMA connectors
- 55 °C to +85 °C Operating Temperature

General Description

The HMC-C059 is a GaAs MMIC pHEMT Low Noise Distributed Amplifier in a miniature, hermetic module with replaceable SMA connectors which operates between 1 and 12 GHz. The amplifier provides 16 dB of gain, 1.8 dB noise figure, and up to +17 dBm of output power at 1 dB gain compression. The wideband amplifier I/Os are internally matched to 50 Ohms and are internally DC blocked. Integrated voltage regulators allow for flexible biasing of both the negative and positive supply pins, while internal bias sequencing circuitry assures robust operation.

Electrical Specifications, $T_A = +25^\circ\text{C}$, $+V_{dc} = +6\text{V}$, $-V_{dc} = -5\text{V}$

Parameter	Min.	Typ.	Max.	Min.	Typ.	Max.	Units
Frequency Range		1 - 8		8 - 12			GHz
Gain	14	16		12	14		dB
Gain Flatness		± 1			± 1.25		dB
Gain Variation Over Temperature		0.005			0.005		dB/°C
Noise Figure		1.75	2.25		2.5	3	dB
Input Return Loss		-12			-7		dB
Output Return Loss		-17			-15		dB
Output Power for 1 dB Compression (P1dB)		17			14		dBm
Saturated Output Power (Psat)		19			17		dBm
Output Third Order Intercept (IP3)		31			29		dBm
Positive Supply Current (+IDC)		60	70		60	70	mA
Negative Supply Current (-IDC)		1.5			1.5		mA

Information furnished by Analog Devices is believed to be accurate and reliable. However, no responsibility is assumed by Analog Devices for its use, nor for any infringements of patents or other rights of third parties that may result from its use. Specifications subject to change without notice. No license is granted by implication or otherwise under any patent or patent rights of Analog Devices. Trademarks and registered trademarks are the property of their respective owners.

For price, delivery, and to place orders: Analog Devices, Inc., One Technology Way, P.O. Box 9106, Norwood, MA 02062-9106
 Phone: 781-329-4700 • Order online at www.analog.com
 Application Support: Phone: 1-800-ANALOG-D

HMC-C059* PRODUCT PAGE QUICK LINKS

Last Content Update: 02/23/2017

[COMPARABLE PARTS](#)

View a parametric search of comparable parts.

[DOCUMENTATION](#)

Application Notes

- AN-1363: Meeting Biasing Requirements of Externally Biased RF/Microwave Amplifiers with Active Bias Controllers

Data Sheet

- HMC-C059 Data Sheet

[DESIGN RESOURCES](#)

- HMC-C059 Material Declaration
- PCN-PDN Information
- Quality And Reliability
- Symbols and Footprints

[DISCUSSIONS](#)

View all HMC-C059 EngineerZone Discussions.

[SAMPLE AND BUY](#)

Visit the product page to see pricing options.

[TECHNICAL SUPPORT](#)

Submit a technical question or find your regional support number.

[DOCUMENT FEEDBACK](#)

Submit feedback for this data sheet.



Broadband Gain & Return Loss

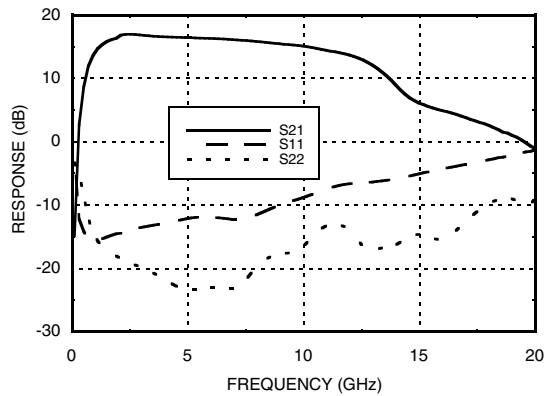

Gain vs. Temperature

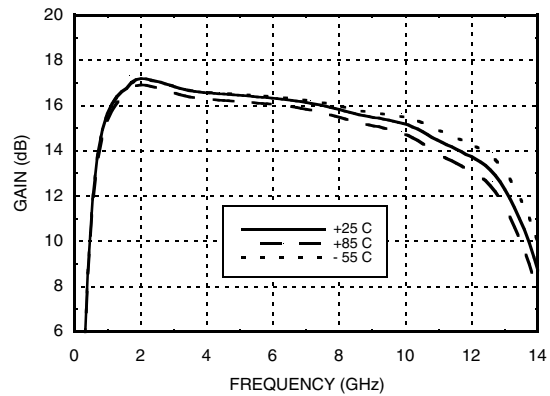

Input Return Loss vs. Temperature

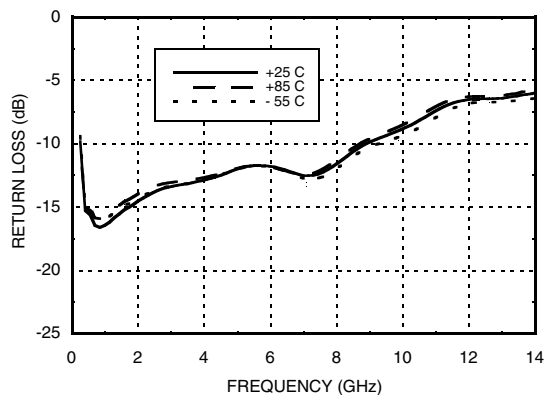

Output Return Loss vs. Temperature

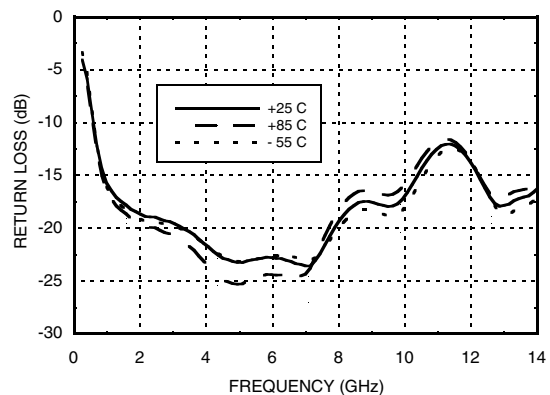

Reverse Isolation vs. Temperature

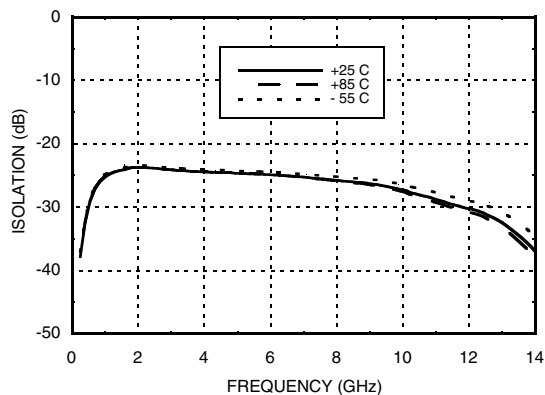

Noise Figure vs. Temperature

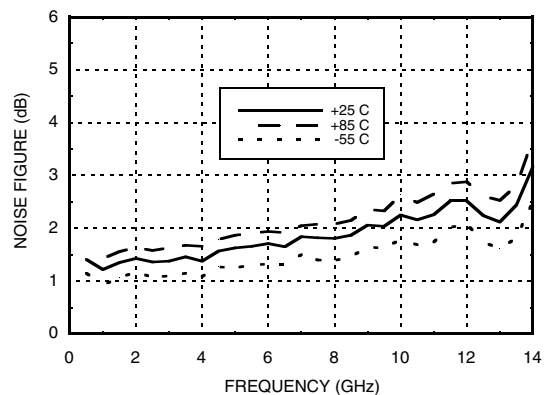

Information furnished by Analog Devices is believed to be accurate and reliable. However, no responsibility is assumed by Analog Devices for its use, nor for any infringements of patents or other rights of third parties that may result from its use. Specifications subject to change without notice. No license is granted by implication or otherwise under any patent or patent rights of Analog Devices. Trademarks and registered trademarks are the property of their respective owners.

For price, delivery, and to place orders: Analog Devices, Inc., One Technology Way, P.O. Box 9106, Norwood, MA 02062-9106 Phone: 781-329-4700 • Order online at www.analog.com Application Support: Phone: 1-800-ANALOG-D

WIDEBAND LNA MODULE, 1 - 12 GHz



P1dB vs. Temperature

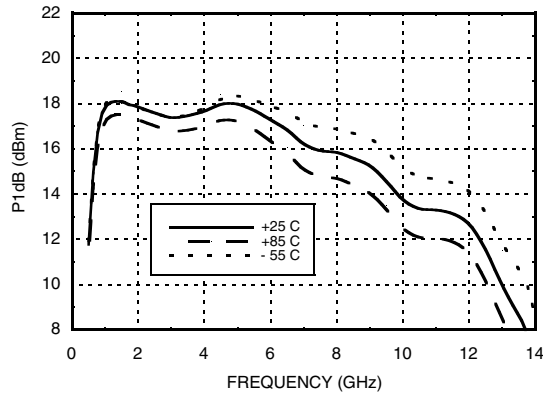

Psat vs. Temperature

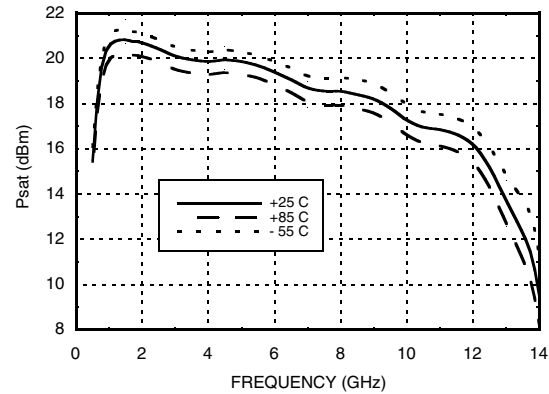

Output IP3 vs. Temperature

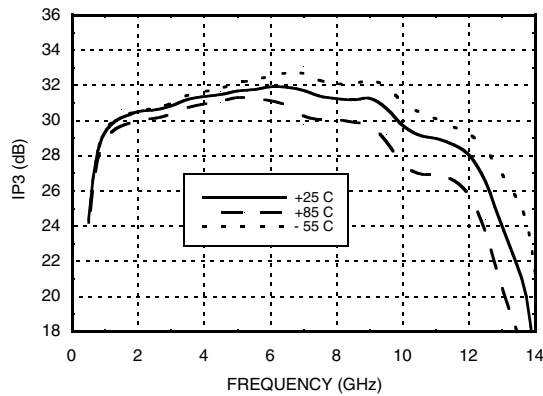

Absolute Maximum Ratings

Positive Bias Supply Voltage (+Vdc)	+16V
Negative Bias Supply (-Vdc)	-12V
RF Input Power (RFIN)	+10 dBm
Storage Temperature	-65 to +150 °C
Operating Temperature	-55 to +85 °C





**ELECTROSTATIC SENSITIVE DEVICE
OBSERVE HANDLING PRECAUTIONS**

Information furnished by Analog Devices is believed to be accurate and reliable. However, no responsibility is assumed by Analog Devices for its use, nor for any infringements of patents or other rights of third parties that may result from its use. Specifications subject to change without notice. No license is granted by implication or otherwise under any patent or patent rights of Analog Devices. Trademarks and registered trademarks are the property of their respective owners.

For price, delivery, and to place orders: Analog Devices, Inc., One Technology Way, P.O. Box 9106, Norwood, MA 02062-9106 Phone: 781-329-4700 • Order online at www.analog.com Application Support: Phone: 1-800-ANALOG-D

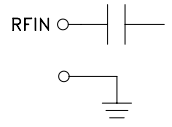

Pin Descriptions

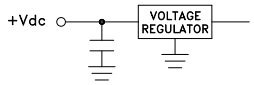
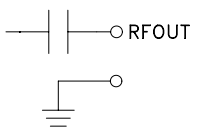
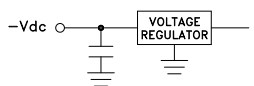
Pin Number	Function	Description	Interface Schematic
1	RFIN & RF Ground	RF input connector, SMA female, field replaceable. This pin is AC coupled and matched to 50 Ohms.	
2, 6	GND	Power supply ground.	
3	+Vdc	Positive power supply voltage for the amplifier.	
4	RFOUT & RF Ground	RF output connector, SMA female. This pin is AC coupled and matched to 50 Ohms.	
5	-Vdc	Negative power supply voltage for the amplifier	



Outline Drawing

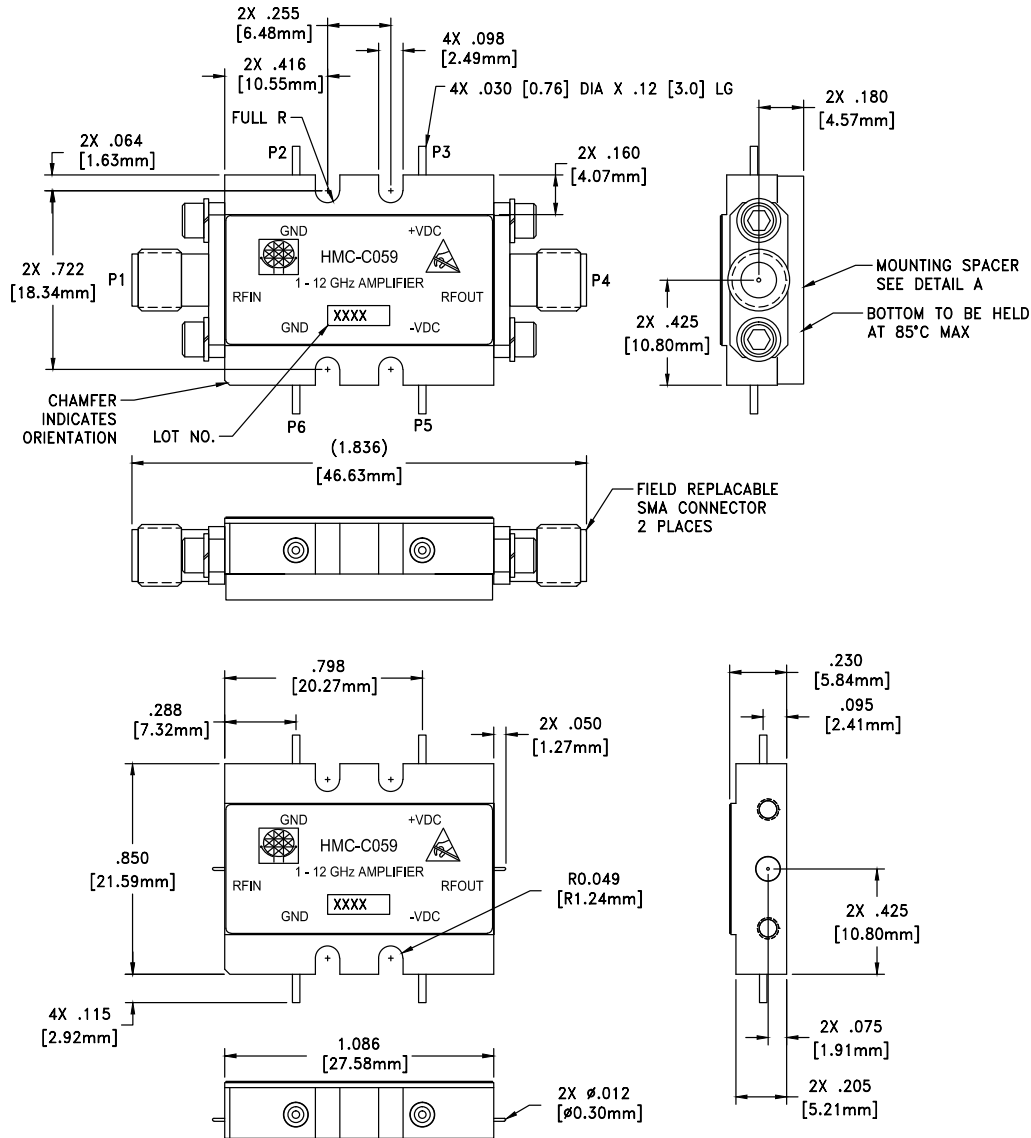

VIEW SHOWN WITH CONNECTORS AND MOUNTING SPACER REMOVED

Package Information

Package Type	C-10
Package Weight [1]	18.7 gms [2]
Spacer Weight	3.3 gms [2]

[1] Includes the connectors

[2] ±1 gms Tolerance

NOTES:

1. PACKAGE, LEADS, COVER MATERIAL: KOVAR™
2. FINISH: GOLD PLATE OVER NICKEL PLATE
3. ALL DIMENSIONS ARE IN INCHES [MILLIMETERS]
4. TOLERANCES:
 - 4.1 .XX = ±0.02
 - 4.2 .XXX = ±0.010
5. FIELD REPLACEABLE 2.92mm CONNECTORS TENSOLITE 231CCSF OR EQUIVALENT

**Notes:**